

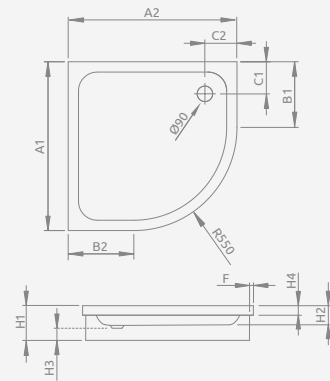

Model	Nr artykułu	Cena brutto
SIROS A 80x80	SBA8817-1	680
SIROS A 90x90	SBA9917-1	711

■ SIROS A

Podstawa styropianowa **do obudowania płytkami**, otwór na syfon $\varnothing 90$ mm, zalecane syfony TB90, TB21, TBXS, R500, R580, R510, 690 P.



SIROS A	A1	A2	B1	B2	C1	C2	F	H1	H2	H3	H4
80x80	800	800	250	250	180	180	15	170	70	90	36
90x90	900	900	350	350	180	180	15	170	70	90	36



Model	Nr artykułu	Cena brutto
SIROS A Compact 80x80	SBA8817-2	661
SIROS A Compact 90x90	SBA9917-2	692

■ SIROS A Compact

Zintegrowana obudowa (ze wszystkich stron), podstawa styropianowa base, otwór na syfon $\varnothing 90$ mm, zalecane syfony TB90, TB21, TBXS, R500, R580, R510, 690 P.

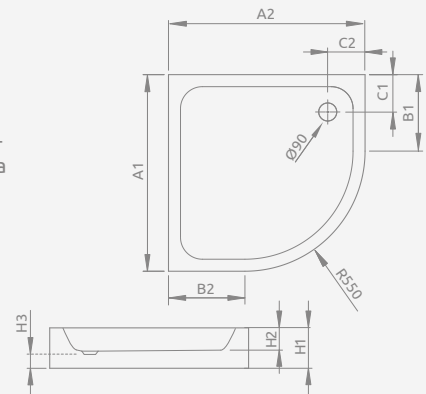

SIROS A Compact	A1	A2	B1	B2	C1	C2	H1	H2	H3
80x80	800	800	250	250	180	180	170	70	90
90x90	900	900	350	350	180	180	170	70	90



Model	Nr artykułu	Cena brutto
NAXOS A 80x80	SBA8841-1	881
NAXOS A 90x90	SBA9941-1	912

■ NAXOS A

Podstawa styropianowa **do obudowania płytkami**, otwór na syfon $\varnothing 50$ mm, zalecane syfony TB50, 578 P.



NAXOS A	A1	A2	B1	B2	C1	C2	D1	D2	H1	H2	H3	H4
80x80	800	800	250	250	210	220	380	380	410	260	130	38
90x90	900	900	350	350	210	220	380	380	410	260	130	38



Model	Nr artykułu	Cena brutto
PATMOS B 90x90	4T99155-03	796

■ PATMOS B

Zdejmowana obudowa, otwór na syfon $\varnothing 90$ mm, stelaż i obudowa w komplecie, zalecane syfony TB21, TBXS, 690 P.

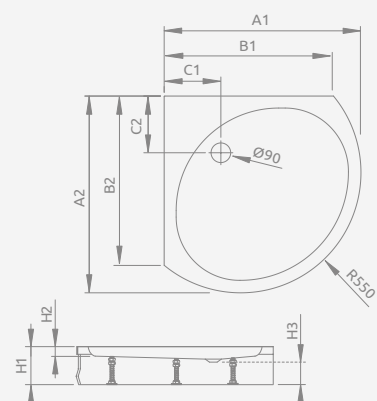

PATMOS B	A1	A2	B1	B2	C1	C2	H1	H2	H3
90 x 90	900	900	780	780	260	260	160	20	80