

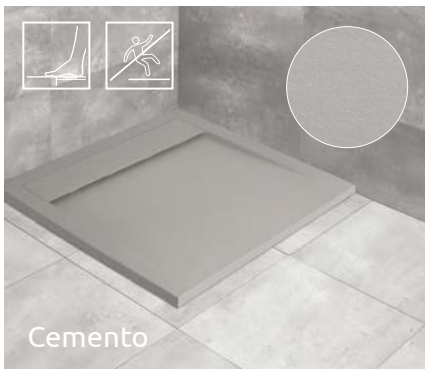

Biały



Cemento



Antracytowy



Czarny

TEOS C

Do montażu bezpośrednio na podłodze, otwór na syfon $\varnothing 90$ mm, zalecany syfon HS1. Brodzik można przyciąć do indywidualnych rozmiarów (szczegóły na str. 552).

TEOS C	A1	A2	B	C1	C2	D	E	H1	H2
80×80	800	800	50	400	125	200	60	40	20
90×90	900	900	150	450	125	200	60	40	20
100×100	1000	1000	250	500	125	200	60	40	20

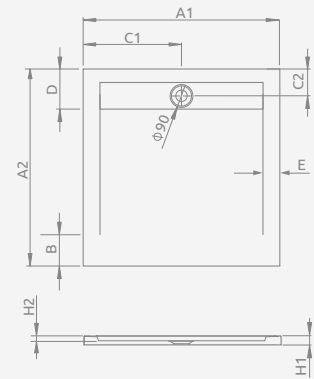

Model	Nr artykułu				Cena brutto
	Biały	Cemento	Antracytowy	Czarny	
TEOS C 80×80	HTC8080-04	HTC8080-74	HTC8080-64	HTC8080-54	1 664
TEOS C 90×90	HTC9090-04	HTC9090-74	HTC9090-64	HTC9090-54	1 885
TEOS C 100×100	HTC100100-04	HTC100100-74	HTC100100-64	HTC100100-54	2 125