

MODELLI DI PIATTI DOCCIA

■ – Piatti doccia in marmo liquido

■ – Piatti doccia in acrilico con base in poliuretano

■ – Piatti doccia in acrilico

Specifiche riguardo i piatti doccia Kyntos e Teos:

– certificato TÜV Rheinland

– 5 anni di garanzia

– Servizio taglio su misura) e servizio finitura in gel coat).

– Sono certificati alla resistenza allo scivolamento secondo la norma DIN 51 097:1992 (classe B ≥ 18°)





– Controlla la disponibilità dei piatti doccia Kyntos e Teos a pagina **360**









Safety
Regular
Production
Surveillance
www.tuv.com
ID 0000073077













| Tutti i disegni tecnici sono disponibili sul nostro sito internet. | | | | | | | | | | | |
|--|------|----------------|------------------|-------------------|---------------------|--|---------|--|--------------------|----------------------|--|
| Modello | Foto | Pannello | Supporti | A filo pavimento | Scarico | Sifoni | Altezza | Dimensioni | N. art. | Prezzo | |
| Quadrato (tipo C) | | | | | | | | | | | |
| Kyntos C White | | × | × | ✓ | Ø 90 | Sifone HS1 e griglia HKA- XX inclusi Scegliere una delle griglie indicate sotto | 30 | 80 × 80 | HKC8080- XX | | |
| Kyntos C Cemento | | × | × | ✓ | | | | Sostituire XX con Cemento = 74 | 90 × 90 | HKC9090- XX | |
| Kyntos C Antracite | | × | × | ✓ | | | | Sostituire XX con Antracite = 64 | 100 × 100 | HKC100100- XX | |
| Kyntos C Black | | × | × | ✓ | | | | Sostituire XX con Nero = 54 | | | |
| Griglia Kyntos | | Inox 01 | Bianco 04 | Cemento 74 | Antracite 64 | Nero 54 | | 13 × 13 | HKA- XX | inclusa | |
| Teos C White | | × | × | ✓ | Ø 90 | Sifone HS1 incluso | 30 | 80 × 80 | HTC8080- XX | | |
| Teos C Cemento | | × | × | ✓ | | | | Sostituire XX con Cemento = 74 | 90 × 90 | HTC9090- XX | |
| Teos C Antracite | | × | × | ✓ | | | | Sostituire XX con Antracite = 64 | 100 × 100 | HTC100100- XX | |
| Teos C Black | | × | × | ✓ | | | | Sostituire XX con Nero = 54 | | | |
| Zantos C | | × | × | ✓ | Ø 90 | TB90, TB21, TBXS, R500, R580, R510 | 32 | 80 × 80 | M3ZNC8080-06 | | |
| | | | | | | | | 90 × 90 | M3ZNC9090-06 | | |

| Tutti i disegni tecnici sono disponibili sul nostro sito internet. | |  |  |  |  |  |  | | | | |
|--|---|---|---|---|---|---|---|------------|-------------------------|------------|--|
| Modello | Foto | Pannello | Supporti | A filo pavimento | Scarico | Sifoni | Altezza | Dimensioni | N. art. | Prezzo | |
| Giaros C |  | ✗ | ✗ | ✓ | Ø 50 | 5SL1 | 40 | 90 × 90 | MKGC9090-03 | | |
| | | | | | | | | 100 × 100 | M3GRC1010 | | |
| Doros Plus C |  | ✗ | ✗ | ✗ | Ø 90 | TB90, TB21, TBXS, R500, R580, R510, R400 SLIM, R400W SLIM, 690 P | 40 | 80 × 80 | SDRPC8080-01 | | |
| | | | | | | | | 90 × 90 | SDRPC9090-01 | | |
| | | | | | | | | 100 × 100 | SDRPC1010-01 | | |
| Doros C |  | ✗ | ✗ | ✗ | Ø 90 | TB90, TB21, TBXS, R500, R580, R510, R400 SLIM, R400W SLIM, 690 P | 45 | 80 × 80 | SDRC8080-01 | | |
| | | | | | | | | 90 × 90 | SDRC9090-01 | | |
| | | | | | | | | 100 × 100 | SDRC1010-01 | | |
| Doros C Stone |  | ✗ | ✗ | ✗ | Ø 90 | TB90, TB21, TBXS, R500, R580, R510, R400 SLIM, R400W SLIM, 690 P | 45 | 80 × 80 | SDRC8080-01- XXS | | |
| | | | | | | | | 90 × 90 | SDRC9090-01- XXS | | |
| | | | | | | | | 100 × 100 | SDRC1010-01- XXS | | |
| Doros C Compact |  | Integrato | ✓ h = 78 | ✗ | Ø 90 | TB90, TB21, TBXS, R500, R580, R510, R400 SLIM, R400W SLIM | 115 | 80 × 80 | SDRC8080-05 | | |
| | | | | | | | | 90 × 90 | SDRC9090-05 | | |
| | | | | | | | | 100 × 100 | SDRC1010-05 | | |
| Doros C Compact Stone |  | Integrato | ✓ h = 78 | ✗ | Ø 90 | TB90, TB21, TBXS, R500, R580, R510, R400 SLIM, R400W SLIM | 115 | 80 × 80 | SDRC8080-05- XXS | | |
| | | | | | | | | 90 × 90 | SDRC9090-05- XXS | | |
| | | | | | | | | 100 × 100 | SDRC1010-05- XXS | | |
| Argos C |  | ✗ | ✗ | ✗ | Ø 90 | R399 | 55 | 80 × 80 | 4AC88-01 | | |
| | | | | | | | | 90 × 90 | 4AC99-01 | | |
| | | | | | | | | 100 × 100 | 4AC1010-01 | | |
| Delos C |  | ✗ | ✗ | ✗ | Ø 90 | TB90, TB21, TBXS, R500, R580, R510, R400 SLIM, R400W SLIM, 690 P | 45 | 80 × 80 | SDC0808-01 | | |
| | | | | | | | | 50 | 90 × 90 | SDC0909-01 | |
| | | | | | | | | 55 | 100 × 100 | SDC1010-01 | |
| Delos C con pannello frontale |  | Pannello removibile (da indicare) | ✓ h = 94 | ✗ | Ø 90 | TB90, TB21, TBXS, R500, R580, R510, R400 SLIM, R400W SLIM, 690 P | 145 | 80 × 80 | 4C88170-03 | | |
| | | | | | | | | 150 | 90 × 90 | 4C99170-03 | |
| | | | | | | | | 155 | 100 × 100 | 4C11170-03 | |

| Tutti i disegni tecnici sono disponibili sul nostro sito internet. | |  |  |  |  |  |  | | | |
|--|---|---|---|---|---|---|---|------------|---------------------|--------|
| Modello | Foto | Pannello | Supporti | A filo pavimento | Scarico | Sifoni | Altezza | Dimensioni | N. art. | Prezzo |
| Rettagonale con scarico sul lato corto (tipo F) | | | | | | | | | | |
| Kyntos F White |  | ✗ | ✗ | ✓ | Ø 90 | Sifone HS1 e griglia HKA- XX inclusi | 30 | 90 × 80 | HKF9080- XX | |
| | | | | | | | | 100 × 70 | HKF10070- XX | |
| | | | | | | | | 100 × 80 | HKF10080- XX | |
| | | | | | | | | 100 × 90 | HKF10090- XX | |
| | | | | | | | | 110 × 80 | HKF11080- XX | |

| Tutti i disegni tecnici sono disponibili sul nostro sito internet. | | | | | | | | | | | | | | | | | | | | | | | | | | | | |
|--|--------------|-----------|-----------|-------------------|---------|--|---------|-----------------------|------------------|----------------|------------------|-------------------|---------------------|--|---------|-----------|----------------|-----------------|--|---|---|---|------|---------------------------|----|----------|-------------|--|
| Modello | Foto | Pan-nello | Sup-porti | A filo pavimen-to | Scarico | Sifoni | Altezza | Dimensioni | N. art. | Prezzo | | | | | | | | | | | | | | | | | | |
| Kyntos F Cemento | | x | x | ✓ | Ø 90 | Sifone HS1 e griglia HKA-XX inclusi | 30 | 110 x 90 | HKF11090-XX | | | | | | | | | | | | | | | | | | | |
| | | | | | | | | 120 x 70 | HKF12070-XX | | | | | | | | | | | | | | | | | | | |
| | | | | | | | | 120 x 80 | HKF12080-XX | | | | | | | | | | | | | | | | | | | |
| | | | | | | | | 120 x 90 | HKF12090-XX | | | | | | | | | | | | | | | | | | | |
| | | | | | | | | 120 x 100 | HKF120100-XX | | | | | | | | | | | | | | | | | | | |
| | | | | | | | | 130 x 80 | HKF13080-XX | | | | | | | | | | | | | | | | | | | |
| | | | | | | | | 130 x 90 | HKF13090-XX | | | | | | | | | | | | | | | | | | | |
| | | | | | | | | 140 x 70 | HKF14070-XX | | | | | | | | | | | | | | | | | | | |
| | | | | | | | | 140 x 80 | HKF14080-XX | | | | | | | | | | | | | | | | | | | |
| | | | | | | | | 140 x 90 | HKF14090-XX | | | | | | | | | | | | | | | | | | | |
| | | | | | | | | 140 x 100 | HKF140100-XX | | | | | | | | | | | | | | | | | | | |
| | | | | | | | | 150 x 80 | HKF15080-XX | | | | | | | | | | | | | | | | | | | |
| | | | | | | | | 150 x 90 | HKF15090-XX | | | | | | | | | | | | | | | | | | | |
| | | | | | | | | 160 x 70 | HKF16070-XX | | | | | | | | | | | | | | | | | | | |
| | | | | | | | | Kyntos F Antracite | | x | x | ✓ | Ø 90 | Sifone HS1 e griglia HKA-XX inclusi | 30 | 160 x 80 | HKF16080-XX | | | | | | | | | | | |
| 160 x 90 | HKF16090-XX | | | | | | | | | | | | | | | | | | | | | | | | | | | |
| 160 x 100 | HKF160100-XX | | | | | | | | | | | | | | | | | | | | | | | | | | | |
| 180 x 70 | HKF18070-XX | | | | | | | | | | | | | | | | | | | | | | | | | | | |
| 180 x 80 | HKF18080-XX | | | | | | | | | | | | | | | | | | | | | | | | | | | |
| 180 x 90 | HKF18090-XX | | | | | | | | | | | | | | | | | | | | | | | | | | | |
| 180 x 100 | HKF180100-XX | | | | | | | | | | | | | | | | | | | | | | | | | | | |
| 210 x 70 | HKF21070-XX | | | | | | | | | | | | | | | | | | | | | | | | | | | |
| 210 x 80 | HKF21080-XX | | | | | | | | | | | | | | | | | | | | | | | | | | | |
| 210 x 90 | HKF21090-XX | | | | | | | | | | | | | | | | | | | | | | | | | | | |
| 210 x 100 | HKF210100-XX | | | | | | | | | | | | | | | | | | | | | | | | | | | |
| Kyntos F Black | | x | x | ✓ | Ø 90 | Sifone HS1 e griglia HKA-XX inclusi | 30 | | | | | | | | | 160 x 100 | HKF160100-XX | | | | | | | | | | | |
| | | | | | | | | | | | | | | | | 180 x 70 | HKF18070-XX | | | | | | | | | | | |
| | | | | | | | | | | | | | | | | 180 x 80 | HKF18080-XX | | | | | | | | | | | |
| | | | | | | | | | | | | | | | | 180 x 90 | HKF18090-XX | | | | | | | | | | | |
| | | | | | | | | 180 x 100 | HKF180100-XX | | | | | | | | | | | | | | | | | | | |
| | | | | | | | | 210 x 70 | HKF21070-XX | | | | | | | | | | | | | | | | | | | |
| | | | | | | | | 210 x 80 | HKF21080-XX | | | | | | | | | | | | | | | | | | | |
| | | | | | | | | 210 x 90 | HKF21090-XX | | | | | | | | | | | | | | | | | | | |
| | | | | | | | | 210 x 100 | HKF210100-XX | | | | | | | | | | | | | | | | | | | |
| | | | | | | | | Griglia Kyntos | | Inox 01 | Bianco 04 | Cemento 74 | Antracite 64 | Nero 54 | 13 x 13 | HKA-XX | inclusa | | | | | | | | | | | |
| | | | | | | | | | | | | | | | | | | Teos F White | | x | x | ✓ | Ø 90 | Sifone HS1 incluso | 30 | 90 x 80 | HTF9080-XX | |
| | | | | | | | | | | | | | | | | | | | | | | | | | | 100 x 70 | HTF10070-XX | |
| | | | | | | | | | | | | | | | | | | | | | | | | | | 100 x 80 | HTF10080-XX | |
| | | | | | | | | | | | | | | | | | | | | | | | | | | 100 x 90 | HTF10090-XX | |
| | | | | | | | | 110 x 80 | HTF11080-XX | | | | | | | | | | | | | | | | | | | |
| 110 x 90 | HTF11090-XX | | | | | | | | | | | | | | | | | | | | | | | | | | | |
| 120 x 70 | HTF12070-XX | | | | | | | | | | | | | | | | | | | | | | | | | | | |
| Teos F Cemento | | x | x | ✓ | Ø 90 | Sifone HS1 incluso | 30 | 120 x 80 | HTF12080-XX | | | | | | | | | | | | | | | | | | | |
| | | | | | | | | 120 x 90 | HTF12090-XX | | | | | | | | | | | | | | | | | | | |
| | | | | | | | | 120 x 100 | HTF120100-XX | | | | | | | | | | | | | | | | | | | |
| | | | | | | | | 130 x 80 | HTF13080-XX | | | | | | | | | | | | | | | | | | | |
| | | | | | | | | 130 x 90 | HTF13090-XX | | | | | | | | | | | | | | | | | | | |
| | | | | | | | | 140 x 70 | HTF14070-XX | | | | | | | | | | | | | | | | | | | |
| | | | | | | | | 140 x 80 | HTF14080-XX | | | | | | | | | | | | | | | | | | | |
| Teos F Antracite | | x | x | ✓ | Ø 90 | Sifone HS1 incluso | 30 | 140 x 90 | HTF14090-XX | | | | | | | | | | | | | | | | | | | |
| | | | | | | | | 140 x 100 | HTF140100-XX | | | | | | | | | | | | | | | | | | | |
| | | | | | | | | 150 x 80 | HTF15080-XX | | | | | | | | | | | | | | | | | | | |
| | | | | | | | | 150 x 90 | HTF15090-XX | | | | | | | | | | | | | | | | | | | |
| | | | | | | | | 160 x 70 | HTF16070-XX | | | | | | | | | | | | | | | | | | | |
| | | | | | | | | 160 x 80 | HTF16080-XX | | | | | | | | | | | | | | | | | | | |
| | | | | | | | | 160 x 90 | HTF16090-XX | | | | | | | | | | | | | | | | | | | |
| Teos F Black | | x | x | ✓ | Ø 90 | Sifone HS1 incluso | 35 | 160 x 100 | HTF160100-XX | | | | | | | | | | | | | | | | | | | |
| | | | | | | | | 180 x 70 | HTF18070-XX | | | | | | | | | | | | | | | | | | | |
| | | | | | | | | 180 x 80 | HTF18080-XX | | | | | | | | | | | | | | | | | | | |
| | | | | | | | | 180 x 90 | HTF18090-XX | | | | | | | | | | | | | | | | | | | |
| | | | | | | | | 180 x 100 | HTF180100-XX | | | | | | | | | | | | | | | | | | | |
| | | | | | | | | 210 x 70 | HTF21070-XX | | | | | | | | | | | | | | | | | | | |
| | | | | | | | | 210 x 80 | HTF21080-XX | | | | | | | | | | | | | | | | | | | |
| Zantos F | | x | x | ✓ | Ø 90 | TB90, TB21, TBXS, R500, R510, R580, R400 SLIM, R400W SLIM, 690 P | 32 | 100 x 80 | M3ZNF1080-06 | | | | | | | | | | | | | | | | | | | |
| | | | | | | | | 100 x 90 | M3ZNF1090-06 | | | | | | | | | | | | | | | | | | | |
| | | | | | | | | 120 x 80 | M3ZNF1280-06 | | | | | | | | | | | | | | | | | | | |
| | | | | | | | | 120 x 90 | M3ZNF1290-06 | | | | | | | | | | | | | | | | | | | |

| Tutti i disegni tecnici sono disponibili sul nostro sito internet. | |  |  |  |  |  |  | | | |
|--|---|---|---|---|---|---|---|------------|--------------------------|--------|
| Modello | Foto | Pannello | Supporti | A filo pavimento | Scarico | Sifoni | Altezza | Dimensioni | N. art. | Prezzo |
| Doros Plus F |  | x | x | x | Ø 90 | TB90, TB21, TBXS, R500, R510, R580, R400 SLIM, R400W SLIM, 690 P | 50 | 90 x 70 | SDRFP9070-01 | |
| | | | | | | | | 100 x 70 | SDRFP1070-01 | |
| | | | | | | | | 100 x 80 | SDRFP1080-01 | |
| | | | | | | | | 120 x 70 | SDRFP1270-01 | |
| | | | | | | | | 120 x 80 | SDRFP1280-01 | |
| | | | | | | | | 120 x 90 | SDRFP1290-01 | |
| Doros F |  | x | x | x | Ø 90 | TB90, TB21, TBXS, R500, R510, R580, R400 SLIM, R400W SLIM, 690 P | 55 | 90 x 70 | SDRF9070-01 | |
| | | | | | | | | 100 x 70 | SDRF1070-01 | |
| | | | | | | | | 100 x 80 | SDRF1080-01 | |
| | | | | | | | | 120 x 70 | SDRF1270-01 | |
| | | | | | | | | 120 x 80 | SDRF1280-01 | |
| | | | | | | | | 120 x 90 | SDRF1290-01 | |
| | | | | | | | | 130 x 80 | SDRF1380-01 | |
| | | | | | | | | 140 x 80 | SDRF1480-01 | |
| | | | | | | | | 140 x 90 | SDRF1490-01 | |
| | | | | | | | | 140 x 100 | SDRF1410-01 | |
| | | | | | | | | 150 x 80 | SDRF1580-01 | |
| | | | | | | | | 150 x 90 | SDRF1590-01 | |
| Doros F Stone |  Bianco stone Antracite stone | x | x | x | Ø 90 | TB90, TB21, TBXS, R500, R510, R580, R400 SLIM, R400W SLIM, 690 P | 55 | 90 x 70 | SDRF9070-01- XXS | |
| | | | | | | | | 100 x 70 | SDRF1070-01- XXS | |
| | | | | | | | | 100 x 80 | SDRF1080-01- XXS | |
| | | | | | | | | 120 x 70 | SDRF1270-01- XXS | |
| | | | | | | | | 120 x 80 | SDRF1280-01- XXS | |
| | | | | | | | | 120 x 90 | SDRF1290-01- XXS | |
| | | | | | | | | 130 x 80 | SDRF1380-01- XXS | |
| | | | | | | | | 140 x 80 | SDRF1480-01- XXS | |
| | | | | | | | | 140 x 90 | SDRF1490-01- XXS | |
| | | | | | | | | 140 x 100 | SDRF1410-01- XXS | |
| | | | | | | | | 150 x 80 | SDRF1580-01- XXS | |
| | | | | | | | | 150 x 90 | SDRF1590-01- XXS | |
| | | | | | | | | 160 x 80 | SDRF1680-01- XXS | |
| | | | | | | | | 160 x 90 | SDRF1690-01- XXS | |
| Doros F Compact |  | Integrato | ✓ h = 75 | x | Ø 90 | TB90, TB21, TBXS, R500, R510, R580, R400 SLIM, R400W SLIM | 120 | 90 x 70 | SDRFP9070-05 | |
| | | | | | | | | 100 x 70 | SDRFP1070-05 | |
| | | | | | | | | 100 x 80 | SDRFP1080-05 | |
| | | | | | | | | 120 x 70 | SDRFP1270-05 | |
| | | | | | | | | 120 x 80 | SDRFP1280-05 | |
| | | | | | | | | 120 x 90 | SDRFP1290-05 | |
| | | | | | | | | 130 x 80 | SDRFP1380-05 | |
| | | | | | | | | 140 x 80 | SDRFP1480-05 | |
| | | | | | | | | 140 x 90 | SDRFP1490-05 | |
| | | | | | | | | 140 x 100 | SDRFP1410-05 | |
| | | | | | | | | 150 x 80 | SDRFP1580-05 | |
| | | | | | | | | 150 x 90 | SDRFP1590-05 | |
| Doros F Compact Stone |  Bianco stone Antracite stone | Integrato | ✓ h = 75 | x | Ø 90 | TB90, TB21, TBXS, R500, R510, R580, R400 SLIM, R400W SLIM | 120 | 90 x 70 | SDRFP9070-05- XXS | |
| | | | | | | | | 100 x 70 | SDRFP1070-05- XXS | |
| | | | | | | | | 100 x 80 | SDRFP1080-05- XXS | |
| | | | | | | | | 120 x 70 | SDRFP1270-05- XXS | |
| | | | | | | | | 120 x 80 | SDRFP1280-05- XXS | |
| | | | | | | | | 120 x 90 | SDRFP1290-05- XXS | |
| | | | | | | | | 130 x 80 | SDRFP1380-05- XXS | |
| | | | | | | | | 140 x 80 | SDRFP1480-05- XXS | |
| | | | | | | | | 140 x 90 | SDRFP1490-05- XXS | |
| | | | | | | | | 140 x 100 | SDRFP1410-05- XXS | |
| | | | | | | | | 150 x 80 | SDRFP1580-05- XXS | |
| | | | | | | | | 150 x 90 | SDRFP1590-05- XXS | |
| 160 x 80 | SDRFP1680-05- XXS | | | | | | | | | |
| 160 x 90 | SDRFP1690-05- XXS | | | | | | | | | |



| Tutti i disegni tecnici sono disponibili sul nostro sito internet. | | | | | | | | | | | |
|--|----------------------------------|-----------|-------------|------------------|---------|--|---------|------------|-------------------------|--------------|---|
| Modello | Foto | Pannello | Supporti | A filo pavimento | Scarico | Sifoni | Altezza | Dimensioni | N. art. | Prezzo | |
| Rettangolare con scarico sul alto lungo (tipo D) | | | | | | | | | | | |
| Giaros D | | ✗ | ✗ | ✓ | Ø 50 | SSL1 | 40 | 90 × 80 | M3GRD9080 | | |
| | | | | | | | | 100 × 80 | MKGD1080-03 | | |
| | | | | | | | | 100 × 90 | MKGD1090-03 | | |
| | | | | | | | | 110 × 80 | M3GRD1180 | | |
| | | | | | | | | 110 × 90 | MKGD1190-03 | | |
| | | | | | | | | 120 × 80 | MKGD1280-03 | | |
| | | | | | | | | 120 × 90 | MKGD1290-03 | | |
| | | | | | | | | 120 × 100 | M3GRD1210 | | |
| Doros Plus D | | ✗ | ✗ | ✗ | Ø 90 | TB90, TB21, TBXS, R500, R510, R580, R400 SLIM, R400W SLIM, 690 P | 40 | 90 × 80 | SDRPD9080-01 | | |
| | | | | | | | | 100 × 80 | SDRPD1080-01 | | |
| | | | | | | | | 100 × 90 | SDRPD1090-01 | | |
| | | | | | | | | 110 × 80 | SDRPD1180-01 | | |
| | | | | | | | | 110 × 90 | SDRPD1190-01 | | |
| | | | | | | | | 120 × 80 | SDRPD1280-01 | | |
| | | | | | | | | 120 × 90 | SDRPD1290-01 | | |
| | | | | | | | | 120 × 100 | SDRPD1210-01 | | |
| | | | | | | | | 45 | 130 × 900 | SDRPD1390-01 | |
| | | | | | | | | Doros D | | ✗ | ✗ |
| 100 × 80 | SDRD1080-01 | | | | | | | | | | |
| 100 × 90 | SDRD1090-01 | | | | | | | | | | |
| 110 × 80 | SDRD1180-01 | | | | | | | | | | |
| 110 × 90 | SDRD1190-01 | | | | | | | | | | |
| 120 × 80 | SDRD1280-01 | | | | | | | | | | |
| 120 × 90 | SDRD1290-01 | | | | | | | | | | |
| 120 × 100 | SDRD1210-01 | | | | | | | | | | |
| 130 × 90 | SDRD1390-01 | | | | | | | | | | |
| Doros D Stone | Bianco stone Antracite stone | ✗ | ✗ | ✗ | Ø 90 | TB90, TB21, TBXS, R500, R510, R580, R400 SLIM, R400W SLIM, 690 P | 50 | 90 × 80 | SDRD9080-01- XXS | | |
| | | | | | | | | 100 × 80 | SDRD1080-01- XXS | | |
| | | | | | | | | 100 × 90 | SDRD1090-01- XXS | | |
| | | | | | | | | 110 × 80 | SDRD1180-01- XXS | | |
| | | | | | | | | 110 × 90 | SDRD1190-01- XXS | | |
| | | | | | | | | 120 × 80 | SDRD1280-01- XXS | | |
| | | | | | | | | 120 × 90 | SDRD1290-01- XXS | | |
| | | | | | | | | 120 × 100 | SDRD1210-01- XXS | | |
| | | | | | | | | 130 × 90 | SDRD1390-01- XXS | | |
| Doros D Compact | | Integrato | ✓ h = 78 | ✗ | Ø 90 | TB90, TB21, TBXS, R500, R510, R580, R400 SLIM, R400W SLIM | 115 | 90 × 80 | SDRD9080-05 | | |
| | | | | | | | | 100 × 80 | SDRD1080-05 | | |
| | | | | | | | | 100 × 90 | SDRD1090-05 | | |
| | | | | | | | | 110 × 80 | SDRD1180-05 | | |
| | | | | | | | | 110 × 90 | SDRD1190-05 | | |
| | | | | | | | | 120 × 80 | SDRD1280-05 | | |
| | | | | | | | | 120 × 90 | SDRD1290-05 | | |
| | | | | | | | | 120 × 100 | SDRD1210-05 | | |
| Doros D Compact Stone | Bianco stone Antracite stone | Integrato | ✓ h = 78 | ✗ | Ø 90 | TB90, TB21, TBXS, R500, R510, R580, R400 SLIM, R400W SLIM | 115 | 90 × 80 | SDRD9080-05- XXS | | |
| | | | | | | | | 100 × 80 | SDRD1080-05- XXS | | |
| | | | | | | | | 100 × 90 | SDRD1090-05- XXS | | |
| | | | | | | | | 110 × 80 | SDRD1180-05- XXS | | |
| | | | | | | | | 110 × 90 | SDRD1190-05- XXS | | |
| | | | | | | | | 120 × 80 | SDRD1280-05- XXS | | |
| | | | | | | | | 120 × 90 | SDRD1290-05- XXS | | |
| | | | | | | | | 120 × 100 | SDRD1210-05- XXS | | |
| | | | | | | | | 130 × 90 | SDRD1390-05- XXS | | |
| Argos D | | ✗ | ✗ | ✗ | Ø 90 | R399 | 55 | 90 × 80 | 4AD89-01 | | |
| | | | | | | | | 100 × 80 | 4AD810-01 | | |
| | | | | | | | | 100 × 90 | 4AD910-01 | | |
| | | | | | | | | 110 × 90 | 4AD911-01 | | |
| | | | | | | | | 120 × 80 | 4AD812-01 | | |
| | | | | | | | | 120 × 90 | 4AD912-01 | | |
| | | | | | | | | 140 × 90 | 4AD914-01 | | |
| | | | | | | | | 150 × 90 | 4AD915-01 | | |
| 160 × 90 | 4AD916-01 | | | | | | | | | | |











| Tutti i disegni tecnici sono disponibili sul nostro sito internet. | | | | | | | | | | |
|--|------|---------------------|-------------|------------------|---------|--|---------|------------|-------------|--------|
| Modello | Foto | Pannello | Supporti | A filo pavimento | Scarico | Sifoni | Altezza | Dimensioni | N. art. | Prezzo |
| Delos D | | ✗ | ✗ | ✗ | Ø 90 | TB90, TB21, TBXS, R500, R510, R580, R400 SLIM, R400W SLIM, 690 P | 45 | 80 × 75 | 4D87545-03 | |
| | | | | | | | 45 | 90 × 75 | 4D97545-03 | |
| | | | | | | | 55 | 100 × 75 | 4D17555-03 | |
| Delos D con pannello frontale | | Pannello removibile | ✓ h = 94 | ✗ | Ø 90 | TB90, TB21, TBXS, R500, R510, R580, R400 SLIM, R400W SLIM, 690 P | 145 | 80 × 75 L | 4D87514-03L | |
| | | | | | | | 145 | 80 × 75 R | 4D87514-03R | |
| | | | | | | | 145 | 90 × 75 L | 4D97514-03L | |
| | | | | | | | 145 | 90 × 75 R | 4D97514-03R | |
| | | | | | | | 155 | 100 × 75 L | 4D17515-03L | |
| | | | | | | | 155 | 100 × 75 R | 4D17515-03R | |

| Tutti i disegni tecnici sono disponibili sul nostro sito internet. | | | | | | | | | | |
|--|------|----------|----------|------------------|---------|--------|---------|------------|---------|--------|
| Modello | Foto | Pannello | Supporti | A filo pavimento | Scarico | Sifoni | Altezza | Dimensioni | N. art. | Prezzo |

Semicircolare simmetrico (tipo A)



| | | | | | | | | | | |
|---------------------|--------------------|----------------------|-----------------------|-------------------------|--------------------|--|----|-----------|----------------------|----------------|
| Kyntos A White | | ✗ | ✗ | ✓ | Ø 90 | Sifone HS1 e griglia HKA- XX inclusi Scegliere una delle griglie indicate sotto | 30 | 80 × 80 | HKA8080- XX | |
| Kyntos A Cemento | | ✗ | ✗ | ✓ | | | | 90 × 90 | HKA9090- XX | |
| Kyntos A Anthracite | | ✗ | ✗ | ✓ | | | | 100 × 100 | HKA100100- XX | |
| Kyntos A Black | | ✗ | ✗ | ✓ | | | | | | |
| Griglia Kyntos | Inox 01 | Bianco 04 | Cemento 74 | Antracite 64 | Nero 54 | | | 13 × 13 | HKA- XX | inclusa |
| Giaros A | | ✗ | ✗ | ✓ | Ø 50 | 5SL1 | 40 | 90 × 90 | MKGA9090-03 | |
| Zantos A | | ✗ | ✗ | ✓ | Ø 90 | TB90, TB21, TBXS, R500, R510, R580, R400 SLIM, R400W SLIM, 690 P | 32 | 90 × 90 | M3ZNA9090-06 | |
| Doros Plus A | | ✗ | ✗ | ✗ | Ø 90 | TB90, TB21, TBXS, R500, R510, R580, R400 SLIM, R400W SLIM, 690 P | 40 | 80 × 80 | SDRPA8080-01 | |
| | | | | | | | | 90 × 90 | SDRPA9090-01 | |

















| Tutti i disegni tecnici sono disponibili sul nostro sito internet. | |  |  |  |  |  |  | | | |
|--|--|---|---|---|---|---|---|---|-------------------------|---------|
| Modello | Foto | Pannello | Supporti | A filo pavimento | Scarico | Sifoni | Altezza | Dimensioni | N. art. | Prezzo |
| Doros A |  | ✗ | ✗ | ✗ | Ø 90 | TB90, TB21, TBXS, R500, R510, R580, R400 SLIM, R400W SLIM, 690 P | 45 | 80 × 80 | SDRA8080-01 | |
| | | | | | | | | 90 × 90 | SDRA9090-01 | |
| Doros A Stone |  | ✗ | ✗ | ✗ | Ø 90 | TB90, TB21, TBXS, R500, R510, R580, R400 SLIM, R400W SLIM, 690 P | 45 | 80 × 80 | SDRA8080-01- XXS | |
| | | | | | | | | Sostituire XX con Bianco = 04 , Antracite = 64 | | 90 × 90 |
| Doros A Compact |  | Integrato | ✓ h = 85 | ✗ | Ø 90 | TB90, TB21, TBXS, R500, R510, R580, R400 SLIM, R400W SLIM | 115 | 80 × 80 | SDRA8080-05 | |
| | | | | | | | | 90 × 90 | SDRA9090-05 | |
| Doros A Compact Stone |  | Integrato | ✓ h = 85 | ✗ | Ø 90 | TB90, TB21, TBXS, R500, R510, R580, R400 SLIM, R400W SLIM | 115 | 80 × 80 | SDRA8080-05- XXS | |
| | | | | | | | | Sostituire XX con Bianco = 04 , Antracite = 64 | | 90 × 90 |

| Tutti i disegni tecnici sono disponibili sul nostro sito internet. | |  |  |  |  |  |  | | | |
|--|------|---|---|---|---|---|---|------------|---------|--------|
| Modello | Foto | Pannello | Supporti | A filo pavimento | Scarico | Sifoni | Altezza | Dimensioni | N. art. | Prezzo |

Semicircolare asimmetrico (tipo E)

| | | | | | | | | | | |
|-----------------|---|---|---|---|------|--|-----|------------|-------------|--|
| Tasos Plus E |  | ✗ | ✗ | ✗ | Ø 90 | TB90, TB21, TBXS, R500, R510, R580, R400 SLIM, R400W SLIM, 690 P | 50 | 100 × 80 L | STE1086-30L | |
| | | | | | | | | 100 × 80 R | STE1086-30R | |
| Delos E |  | ✗ | ✗ | ✗ | Ø 90 | TB90, TB21, TBXS, R500, R510, R580, R400 SLIM, R400W SLIM, 690 P | 45 | 90 × 80 L | SDE9080-01L | |
| | | | | | | | | 90 × 80 R | SDE8090-01R | |
| | | | | | | | | 100 × 80 L | SDE1080-01L | |
| | | | | | | | | 100 × 80 R | SDE1080-01R | |
| | | | | | | | | 100 × 90 L | SDE1090-01L | |
| | | | | | | | | 100 × 90 R | SDE1090-01R | |
| Delos E Compact |  | ✗ | ✗ | ✗ | Ø 90 | TB90, TB21, TBXS, R500, R510, R580, R400 SLIM, R400W SLIM | 115 | 90 × 80 L | SDE9080-05L | |
| | | | | | | | | 90 × 80 R | SDE9080-05R | |
| | | | | | | | | 100 × 80 L | SDE1080-05L | |
| | | | | | | | | 100 × 80 R | SDE1080-05R | |
| | | | | | | | | 100 × 90 L | SDE1090-05L | |
| | | | | | | | | 100 × 90 R | SDE1090-05R | |

| Tutti i disegni tecnici sono disponibili sul nostro sito internet. | |  |  |  |  |  |  | | | |
|--|---|---|---|---|---|---|---|------------|---------------------------|--------|
| Modello | Foto | Pannello | Supporti | A filo pavimento | Scarico | Sifoni | Altezza | Dimensioni | N. art. | Prezzo |
| Pentagonale (tipo PT) | | | | | | | | | | |
| Doros Plus PT |  | x | x | x | Ø 90 | TB90, TB21, TBXS, R500, R510, R580, R400 SLIM, R400W SLIM, 690 P | 40 | 80x80 | SDRPTP8080-01 | |
| | | | | | | | | 90x90 | SDRPTP9090-01 | |
| | | | | | | | | 100x100 | SDRPTP1010-01 | |
| Doros Plus PT E |  | x | x | x | Ø 90 | TB90, TB21, TBXS, R500, R510, R580, R400 SLIM, R400W SLIM, 690 P | 40 | 100x80 L | SDRPTP1080-01L | |
| | | | | | | | | 100x80 R | SDRPTP1080-01R | |
| | | | | | | | | 100x90 L | SDRPTP1090-01L | |
| | | | | | | | | 100x90 R | SDRPTP1090-01R | |
| Doros PT |  | x | x | x | Ø 90 | TB90, TB21, TBXS, R500, R510, R580, R400 SLIM, R400W SLIM, 690 P | 50 | 80x80 | SDRPT8080-01 | |
| | | | | | | | | 90x90 | SDRPT9090-01 | |
| | | | | | | | | 100x100 | SDRPT1010-01 | |
| Doros PT Stone |  | x | x | x | Ø 90 | TB90, TB21, TBXS, R500, R510, R580, R400 SLIM, R400W SLIM, 690 P | 50 | 80x80 | SDRPT8080-01- XXS | |
| | | | | | | | | 90x90 | SDRPT9090-01- XXS | |
| | | | | | | | | 100x100 | SDRPT1010-01- XXS | |
| Doros PT Compact |  | x | ✓ h = 75 | x | Ø 90 | TB90, TB21, TBXS, R500, R510, R580, R400 SLIM, R400W SLIM | 115 | 80x80 | SDRPT8080-05 | |
| | | | | | | | | 90x90 | SDRPTP9090-05 | |
| | | | | | | | | 100x100 | SDRPT1010-05 | |
| Doros PT Compact Stone |  | x | ✓ h = 75 | x | Ø 90 | TB90, TB21, TBXS, R500, R510, R580, R400 SLIM, R400W SLIM | 115 | 80x80 | SDRPT8080-05- XXS | |
| | | | | | | | | 90x90 | SDRPTP9090-05- XXS | |
| | | | | | | | | 100x100 | SDRPT1010-05- XXS | |
| Doros PT E |  | x | x | x | Ø 90 | TB90, TB21, TBXS, R500, R510, R580, R400 SLIM, R400W SLIM, 690 P | 50 | 100x80 L | SDRPT1080-01L | |
| | | | | | | | | 100x80 R | SDRPT1080-01R | |
| | | | | | | | | 100x90 L | SDRPT1090-01L | |
| | | | | | | | | 100x90 R | SDRPT1090-01R | |
| Doros PT E Compact |  | Integrato | ✓ h = 75 | x | Ø 90 | TB90, TB21, TBXS, R500, R510, R580, R400 SLIM, R400W SLIM | 115 | 100x80 L | SDRPTP1080-05L | |
| | | | | | | | | 100x80 R | SDRPTP1080-05R | |
| | | | | | | | | 100x90 L | SDRPTP1090-05L | |
| | | | | | | | | 100x90 R | SDRPTP1090-05R | |



Misurazione del raggio del piatto doccia

I box doccia semicircolari di Radaway sono adatti per l'installazione su piatti doccia con raggio di 550 mm. È possibile determinare il raggio del piatto doccia utilizzando la seguente formula

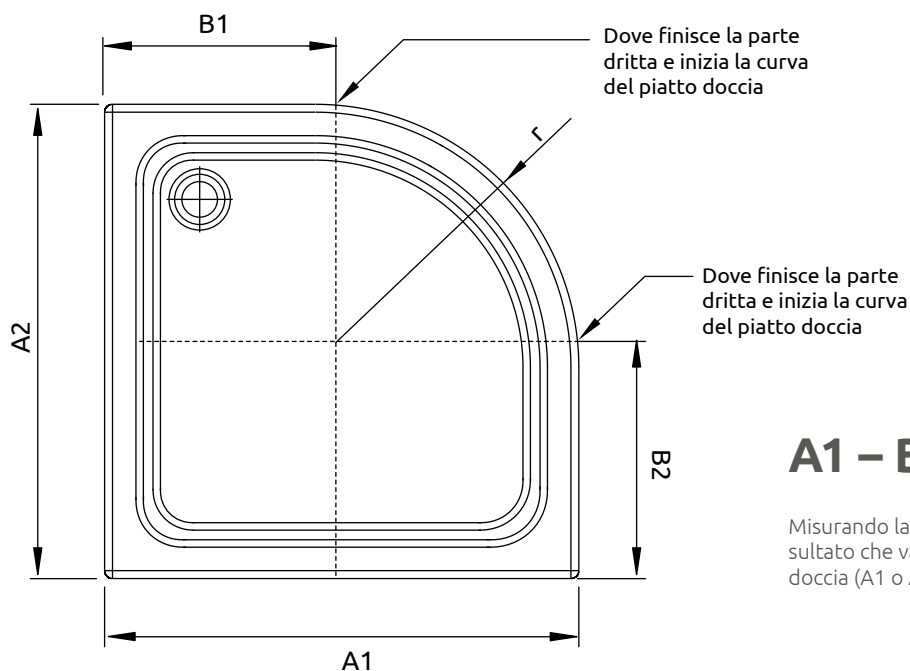

$$A1 - B1 = r = A2 - B2$$

Misurando la parte dritta (B1 o B2) si ottiene un risultato che va sottratto alla dimensione del piatto doccia (A1 o A2) per ricavarne il raggio (r).

Progettazione tramite sito web di piatti doccia e box doccia asimmetrico

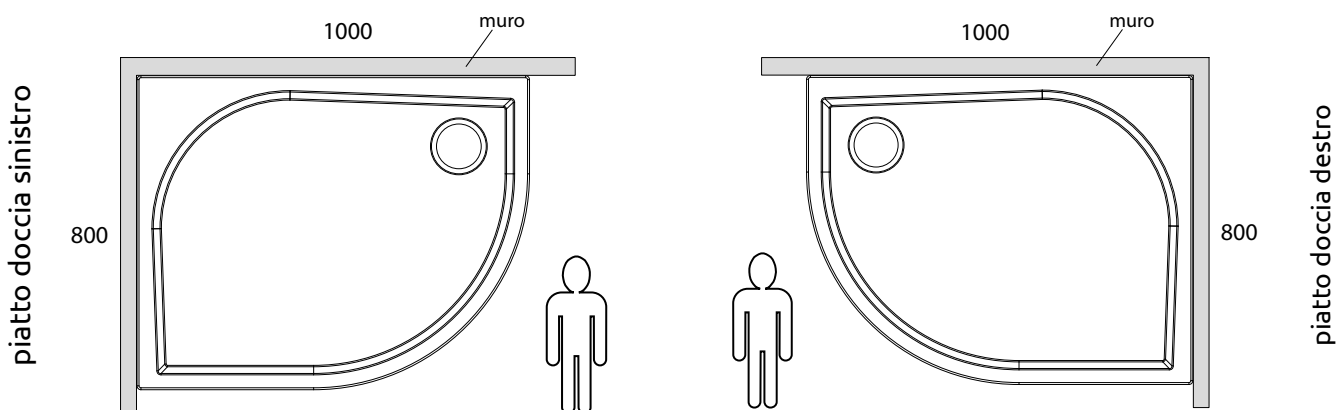

Forma pentagonale asimmetrica: consigli per ordinare

Versione sinistra

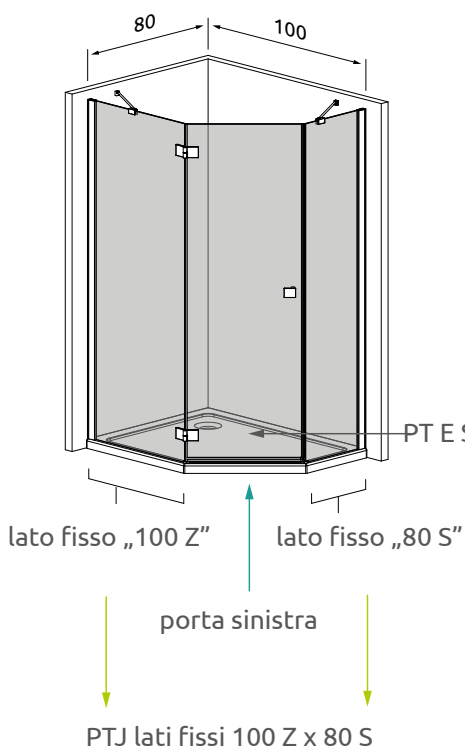

Versione sinistra

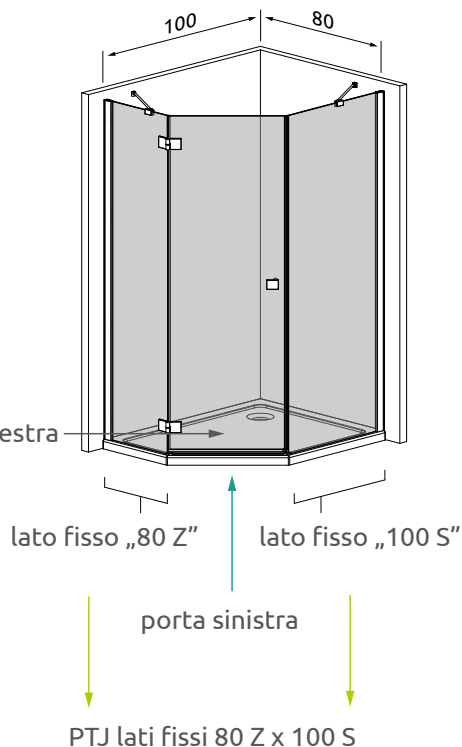

Versione destra

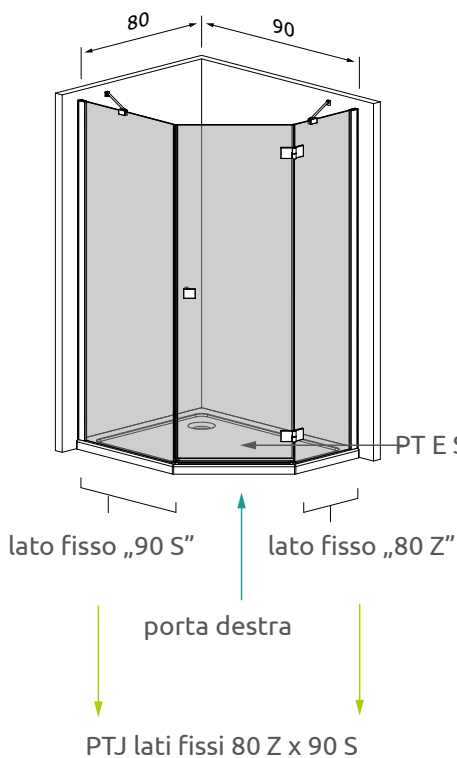

Versione destra

