

Essenza Pro DWJ

Other colour versions of products from the series can be found on p. 170

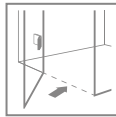
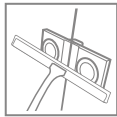
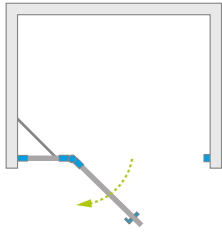

Profile finish:

Glossy:

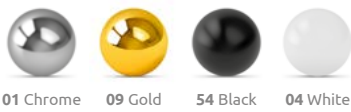

01 Chrome 09 Gold 54 Black 04 White

Matte:



91 Nickel 99 Gold 92 GunMetal 93 Copper



Essenza Pro DWJ + Giaros C

In the article number, the symbol "XX" should be replaced with the symbol of the selected colour: 09, 91, 92, 93, 99

Model	TRANSPARENT GLASS			
	profile finish: CHROME Art. No.	profile finish: BLACK Art. No.	profile finish: WHITE Art. No.	profile finish: OTHERS Art. No.
DWJ 80 L	10099080-01-01L	10099080-54-01L	10099080-04-01L	10099080-XX-01L
DWJ 80 R	10099080-01-01R	10099080-54-01R	10099080-04-01R	10099080-XX-01R
DWJ 90 L	10099090-01-01L	10099090-54-01L	10099090-04-01L	10099090-XX-01L
DWJ 90 R	10099090-01-01R	10099090-54-01R	10099090-04-01R	10099090-XX-01R
DWJ 100 L	10099100-01-01L	10099100-54-01L	10099100-04-01L	10099100-XX-01L
DWJ 100 R	10099100-01-01R	10099100-54-01R	10099100-04-01R	10099100-XX-01R
DWJ 110 L	10099110-01-01L	10099110-54-01L	10099110-04-01L	10099110-XX-01L
DWJ 110 R	10099110-01-01R	10099110-54-01R	10099110-04-01R	10099110-XX-01R
DWJ 120 L	10099120-01-01L	10099120-54-01L	10099120-04-01L	10099120-XX-01L
DWJ 120 R	10099120-01-01R	10099120-54-01R	10099120-04-01R	10099120-XX-01R
DWJ 130 L	10099130-01-01L	10099130-54-01L	10099130-04-01L	10099130-XX-01L
DWJ 130 R	10099130-01-01R	10099130-54-01R	10099130-04-01R	10099130-XX-01R

TECHNICAL DRAWINGS

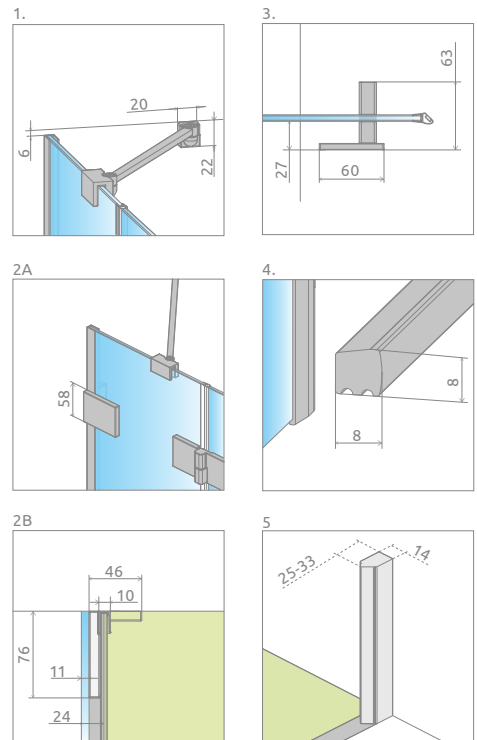
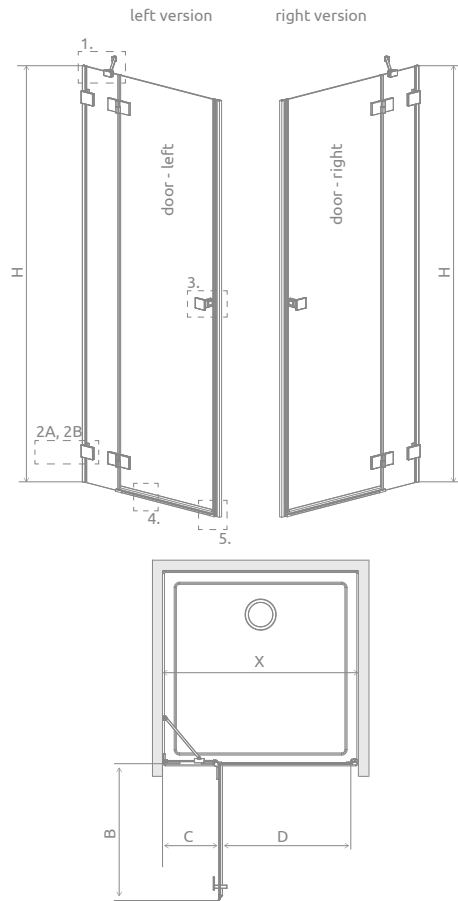

There is a possibility of a paid replacement of transparent gaskets (magnetic, vertical and horizontal) for black gaskets. This option should be clearly stated in the order.

Model	X	B	C	D	H
DWJ 80*	792-808	530	257-265	505	2000
DWJ 90*	892-908	630	257-265	605	2000
DWJ 100*	992-1008	630	357-365	605	2000
DWJ 110*	1092-1108	730	357-365	705	2000
DWJ 120*	1192-1208	830	357-365	805	2000
DWJ 130	1292-1308	830	457-465	805	2000

ADDITIONAL OPTIONS

MADE TO MEASURE p. 5	GLASS VARIANTS p. 9	PRINT/ENGRAVING ON GLASS p. 22/26	STABILIZER L p. 11	HANDLE EXCHANGE OPTION p. 14	MAXIMUM HEIGHT p. 15	GASKETS COLOUR EXCHANGE p. 15

RECOMMENDED SHOWER TRAYS

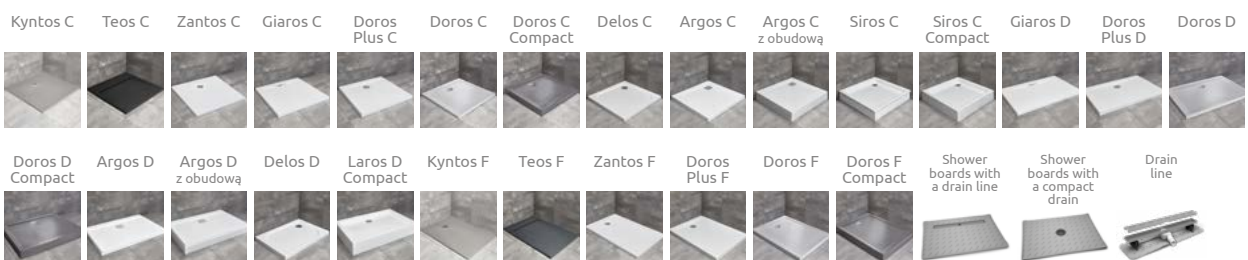

Dimensions are given in mm.