

Essenza Pro PDD

Other colour versions of products from the series can be found on p. 170

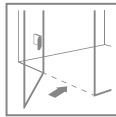
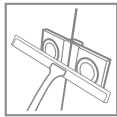
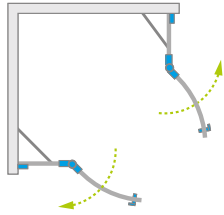

Profile finish:

Glossy:

Matte:



01 Chrome

09 Gold

54 Black

04 White

Brushed:



91 Nickel

99 Gold

92 GunMetal

93 Copper



Essenza Pro PDD + Delos A

Shower enclosure set consists of 2 parts: left and right.
Please specify both article numbers when making an order.

In the article number, the symbol "XX" should be replaced with the symbol of the selected colour: 09, 91, 92, 93, 99

LEFT PART

Model	TRANSPARENT GLASS			
	profile finish: CHROME Art. No.	profile finish: BLACK Art. No.	profile finish: WHITE Art. No.	profile finish: OTHERS Art. No.
PDD 80 L	10095080-01-01L	10095080-54-01L	10095080-04-01L	10095080-XX-01L
PDD 90 L	10095090-01-01L	10095090-54-01L	10095090-04-01L	10095090-XX-01L
PDD 100 L	10095100-01-01L	10095100-54-01L	10095100-04-01L	10095100-XX-01L

In the article number, the symbol "XX" should be replaced with the symbol of the selected colour: 09, 91, 92, 93, 99

RIGHT PART

Model	TRANSPARENT GLASS			
	profile finish: CHROME Art. No.	profile finish: BLACK Art. No.	profile finish: WHITE Art. No.	profile finish: OTHERS Art. No.
PDD 80 R	10095080-01-01R	10095080-54-01R	10095080-04-01R	10095080-XX-01R
PDD 90 R	10095090-01-01R	10095090-54-01R	10095090-04-01R	10095090-XX-01R
PDD 100 R	10095100-01-01R	10095100-54-01R	10095100-04-01R	10095100-XX-01R

TECHNICAL DRAWINGS

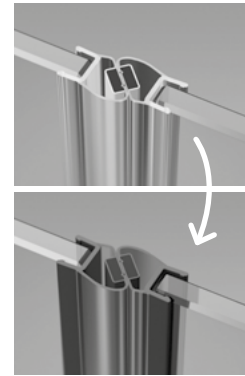
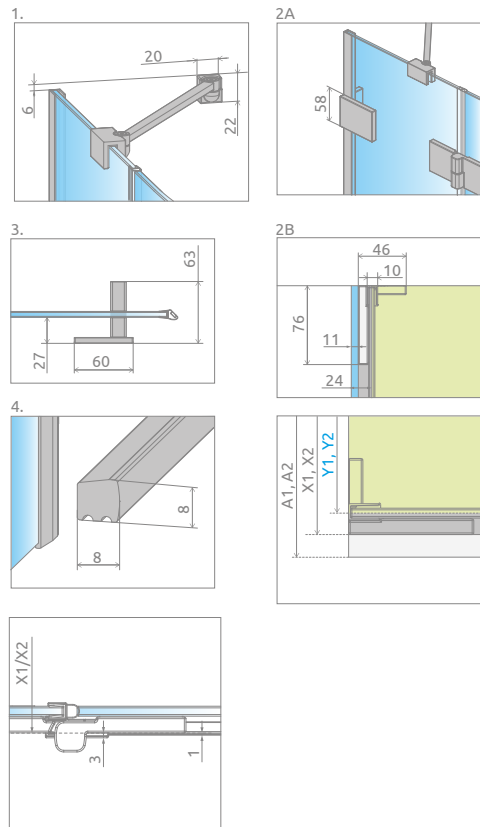
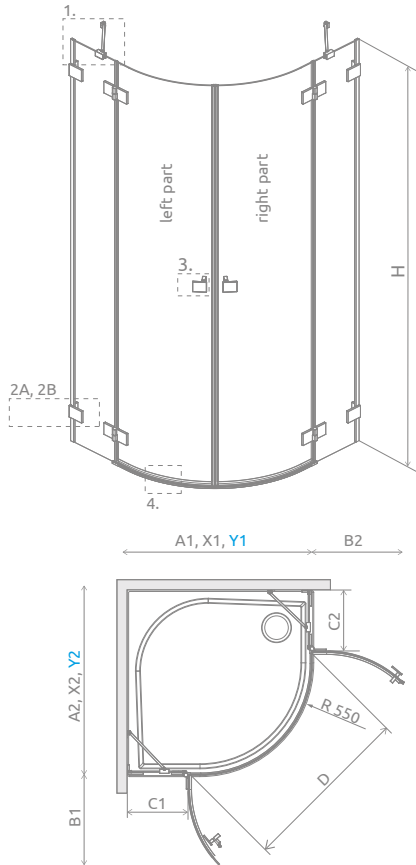

There is a possibility of a paid replacement of transparent gaskets for black gaskets:

- option no. 1 - only magnetic gaskets,
- option no. 2 - all gaskets (magnetic, vertical and horizontal).

The selected option must be clearly stated in the order.

Model	A1	A2	X1	X2	Y1	Y2	B1	B2	C1	C2	D	H
PDD 80Lx80R	800	800	789-797	789-797	776-784	776-784	446	446	193-201	193-201	825	2000
PDD 80Lx90R	800	900	789-797	889-897	776-784	876-884	446	446	193-201	293-301	825	2000
PDD 80Lx100R	800	1000	789-797	989-997	776-784	976-984	446	446	193-201	393-401	825	2000
PDD 90Lx80R	900	800	889-897	789-797	876-884	776-784	446	446	293-301	193-201	825	2000
PDD 90Lx90R*	900	900	889-897	889-897	876-884	876-884	446	446	293-301	293-301	825	2000
PDD 90Lx100R*	900	1000	889-897	989-997	876-884	976-984	446	446	293-301	393-401	825	2000
PDD 100Lx80R	1000	800	989-997	789-797	976-984	776-784	446	446	393-401	193-201	825	2000
PDD 100Lx90R*	1000	900	989-997	889-897	976-984	876-884	446	446	393-401	293-301	825	2000
PDD 100Lx100R*	1000	1000	989-997	989-997	976-984	976-984	446	446	393-401	393-401	825	2000

ADDITIONAL OPTIONS

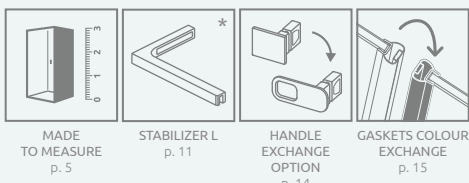

RECOMMENDED SHOWER TRAYS



Dimensions are given in mm.