

Furo KDD

Other colour versions of products from the series can be found on p. 112

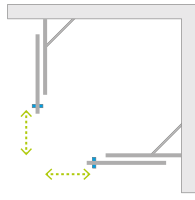

Profile finish:

Glossy:

Matte:



01 Chrome

09 Gold

54 Black

Brushed:



91 Nickel

99 Gold

92 GunMetal

93 Copper



Furo KDD + Teos C Cemento



Shower enclosure set consists of 2 parts: left and right.
Please specify both article numbers when making an order.

In the article number, the symbol "XX" should be replaced with the symbol of the selected colour:
09, 91, 92, 93, 99

LEFT PART

Model	TRANSPARENT GLASS		
	profile finish: CHROME Art. No.	profile finish: BLACK Art. No.	profile finish: OTHERS Art. No.
KDD 80 L	10105080-01-01L	10105080-54-01L	10105080-XX-01L
KDD 90 L	10105090-01-01L	10105090-54-01L	10105090-XX-01L
KDD 100 L	10105100-01-01L	10105100-54-01L	10105100-XX-01L
KDD 110 L	10105110-01-01L	10105110-54-01L	10105110-XX-01L
KDD 120 L	10105120-01-01L	10105120-54-01L	10105120-XX-01L

In the article number, the symbol "XX" should be replaced with the symbol of the selected colour:
09, 91, 92, 93, 99

RIGHT PART

Model	TRANSPARENT GLASS		
	profile finish: CHROME Art. No.	profile finish: BLACK Art. No.	profile finish: OTHERS Art. No.
KDD 80 R	10105080-01-01R	10105080-54-01R	10105080-XX-01R
KDD 90 R	10105090-01-01R	10105090-54-01R	10105090-XX-01R
KDD 100 R	10105100-01-01R	10105100-54-01R	10105100-XX-01R
KDD 110 R	10105110-01-01R	10105110-54-01R	10105110-XX-01R
KDD 120 R	10105120-01-01R	10105120-54-01R	10105120-XX-01R

TECHNICAL DRAWINGS

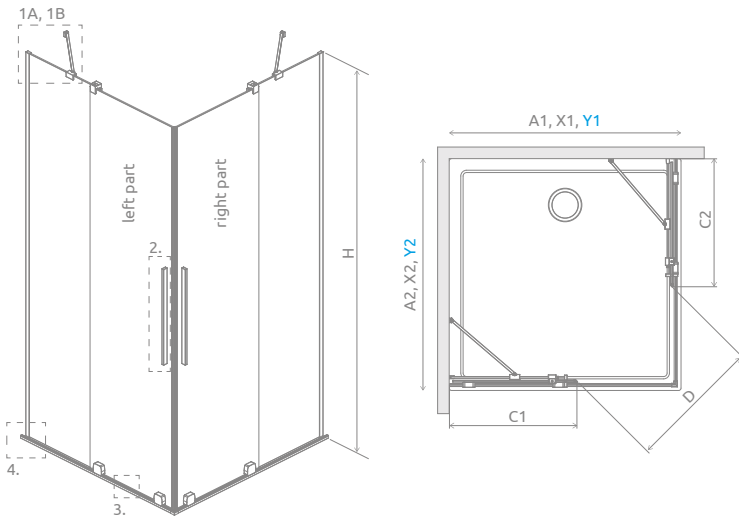

When installed on a shower tray – the minimum width of the edge of the shower tray is 43 mm, and its slope max 1 mm.

Model	A1	A2	X1	X2	Y1	Y2	C1	C2	D	H
KDD 80Lx80R	800	800	750-760	750-760	744-754	744-754	454-464	454-464	435	2000
KDD 80Lx90R	800	900	750-760	850-860	744-754	844-854	454-464	504-514	472	2000
KDD 80Lx100R	800	1000	750-760	950-960	744-754	944-954	454-464	554-564	511	2000
KDD 80Lx110R	800	1100	750-760	1050-1060	744-754	1044-1054	454-464	604-614	551	2000
KDD 80Lx120R	800	1200	750-760	1150-1160	744-754	1144-1154	454-464	654-664	594	2000
KDD 90Lx80R	900	800	850-860	750-760	844-854	744-754	504-514	454-464	472	2000
KDD 90Lx90R	900	900	850-860	850-860	844-854	844-854	504-514	504-514	506	2000
KDD 90Lx100R	900	1000	850-860	950-960	844-854	944-954	504-514	554-564	542	2000
KDD 90Lx110R	900	1100	850-860	1050-1060	844-854	1044-1054	504-514	604-614	581	2000
KDD 90Lx120R	900	1200	850-860	1150-1160	844-854	1144-1154	504-514	654-664	621	2000
KDD 100Lx80R	1000	800	950-960	750-760	944-954	744-754	554-564	454-464	511	2000
KDD 100Lx90R	1000	900	950-960	850-860	944-954	844-854	554-564	504-514	542	2000
KDD 100Lx100R	1000	1000	950-960	950-960	944-954	944-954	554-564	554-564	577	2000
KDD 100Lx110R	1000	1100	950-960	1050-1060	944-954	1044-1054	554-564	604-614	613	2000
KDD 100Lx120R	1000	1200	950-960	1150-1160	944-954	1144-1154	554-564	654-664	651	2000
KDD 110Lx80R	1100	800	1050-1060	750-760	1044-1054	744-754	604-614	454-464	551	2000
KDD 110Lx90R	1100	900	1050-1060	850-860	1044-1054	844-854	604-614	504-514	581	2000
KDD 110Lx100R	1100	1000	1050-1060	950-960	1044-1054	944-954	604-614	554-564	613	2000
KDD 110Lx110R	1100	1100	1050-1060	1050-1060	1044-1054	1044-1054	604-614	604-614	647	2000
KDD 110Lx120R	1100	1200	1050-1060	1150-1160	1044-1054	1144-1154	604-614	654-664	684	2000
KDD 120Lx80R	1200	800	1150-1160	750-760	1144-1154	744-754	654-664	454-464	594	2000
KDD 120Lx90R	1200	900	1150-1160	850-860	1144-1154	844-854	654-664	504-514	621	2000
KDD 120Lx100R	1200	1000	1150-1160	950-960	1144-1154	944-954	654-664	554-564	651	2000
KDD 120Lx110R	1200	1100	1150-1160	1050-1060	1144-1154	1044-1054	654-664	604-614	684	2000
KDD 120Lx120R	1200	1200	1150-1160	1150-1160	1144-1154	1144-1154	654-664	654-664	718	2000

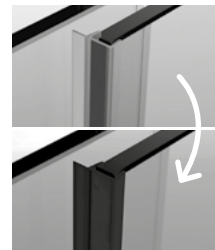
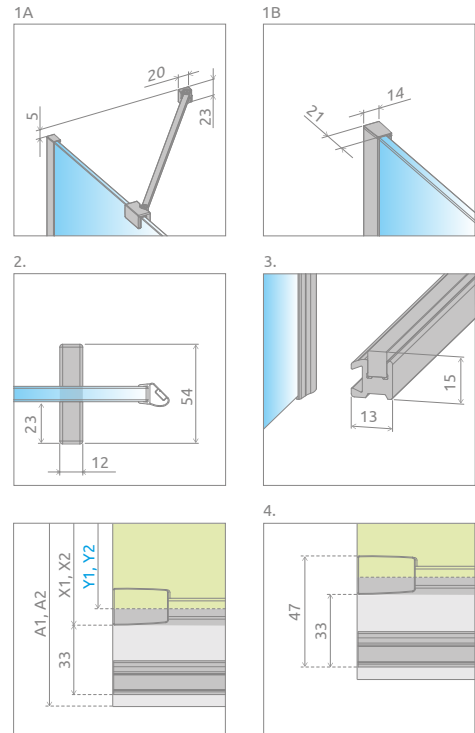

There is a possibility of a paid replacement of transparent gaskets for black gaskets:

- option no.1 – only magnetic gaskets,
 - option no. 2 – all gaskets (magnetic, vertical and horizontal).
- The selected option must be clearly stated in the order.

It is possible to make the product with a railing handle which also functions as a towel hanger.

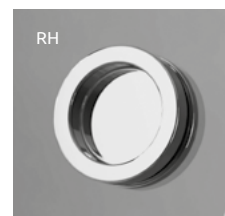

It is possible to extend the entrance by 43 mm by replacing the vertical handle with a round one¹⁾. Please contact the Department of Non-standard Shower Enclosures

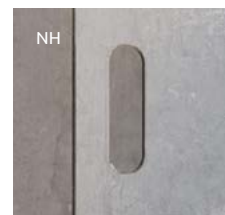

Possibility of replacing the standard handle with a 35x120 mm hole cut in the glass pane.

ADDITIONAL OPTIONS

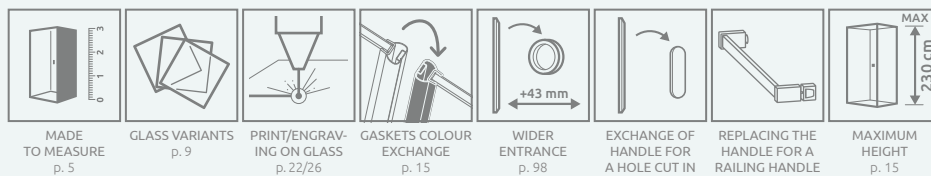

RECOMMENDED SHOWER TRAYS



¹⁾ only chrome and black colour
Dimensions are given in mm.