

Furo PND II

Other colour versions of products from the series can be found on p. 404

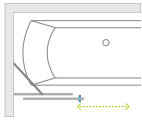

ADDITIONAL OPTIONS

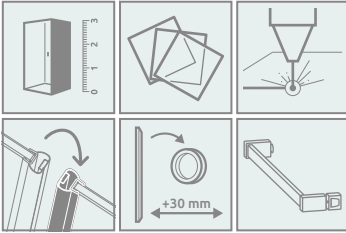

Profile finish:

Glossy:

Matte:



01 Chrome 09 Gold 54 Black

Brushed:



91 Nickel 99 Gold 92 GunMetal 93 Copper



Bathroom screen consists of 2 parts: door and front wall.
Please specify all the article numbers when making an order.

In the article number, the symbol "XX" should be replaced with the symbol of the selected colour: 09, 91, 92, 93, 99

Model	Element	TRANSPARENT GLASS		
		profile finish: CHROME Art. No.	profile finish: BLACK Art. No.	profile finish: OTHERS Art. No.
PND II 100 L	PND II door 538 L	10109538-01-01L	10109538-54-01L	10109538-XX-01L
	Front wall PN 494	10112494-01-01	10112494-01-01	10112494-01-01
PND II 100 R	PND II door 538 R	10109538-01-01R	10109538-54-01R	10109538-XX-01R
	Front wall PN 494	10112494-01-01	10112494-01-01	10112494-01-01
PND II 110 L	PND II door 588 L	10109588-01-01L	10109588-54-01L	10109588-XX-01L
	Front wall PN 544	10112544-01-01	10112544-01-01	10112544-01-01
PND II 110 R	PND II door 588 R	10109588-01-01R	10109588-54-01R	10109588-XX-01R
	Front wall PN 544	10112544-01-01	10112544-01-01	10112544-01-01
PND II 120 L	PND II door 638 L	10109638-01-01L	10109638-54-01L	10109638-XX-01L
	Front wall PN 594	10112594-01-01	10112594-01-01	10112594-01-01
PND II 120 R	PND II door 638 R	10109638-01-01R	10109638-54-01R	10109638-XX-01R
	Front wall PN 594	10112594-01-01	10112594-01-01	10112594-01-01
PND II 130 L	PND II door 688 L	10109688-01-01L	10109688-54-01L	10109688-XX-01L
	Front wall PN 644	10112644-01-01	10112644-01-01	10112644-01-01
PND II 130 R	PND II door 688 R	10109688-01-01R	10109688-54-01R	10109688-XX-01R
	Front wall PN 644	10112644-01-01	10112644-01-01	10112644-01-01
PND II 140* L	PND II door 738 L	10109738-01-01L	10109738-54-01L	10109738-XX-01L
	Front wall PN 694	10112694-01-01	10112694-01-01	10112694-01-01
PND II 140* R	PND II door 738 R	10109738-01-01R	10109738-54-01R	10109738-XX-01R
	Front wall PN 694	10112694-01-01	10112694-01-01	10112694-01-01
PND II 150* L	PND II door 788 L	10109788-01-01L	10109788-54-01L	10109788-XX-01L
	Front wall PN 744	10112744-01-01	10112744-01-01	10112744-01-01
PND II 150* R	PND II door 788 R	10109788-01-01R	10109788-54-01R	10109788-XX-01R
	Front wall PN 744	10112744-01-01	10112744-01-01	10112744-01-01
PND II 160* L	PND II door 838 L	10109838-01-01L	10109838-54-01L	10109838-XX-01L
	Front wall PN 794	10112794-01-01	10112794-01-01	10112794-01-01
PND II 160* R	PND II door 838 R	10109838-01-01R	10109838-54-01R	10109838-XX-01R
	Front wall PN 794	10112794-01-01	10112794-01-01	10112794-01-01
PND II 170* L	PND II door 888 L	10109888-01-01L	10109888-54-01L	10109888-XX-01L
	Front wall PN 844	10112844-01-01	10112844-01-01	10112844-01-01
PND II 170* R	PND II door 888 R	10109888-01-01R	10109888-54-01R	10109888-XX-01R
	Front wall PN 844	10112844-01-01	10112844-01-01	10112844-01-01
PND II 180* L	PND II door 938 L	10109938-01-01L	10109938-54-01L	10109938-XX-01L
	Front wall PN 894	10112894-01-01	10112894-01-01	10112894-01-01
PND II 180* R	PND II door 938 R	10109938-01-01R	10109938-54-01R	10109938-XX-01R
	Front wall PN 894	10112894-01-01	10112894-01-01	10112894-01-01

* For dimensions ≥ 1400 mm, the bathtub screen has a perpendicular support bar

TECHNICAL DRAWINGS

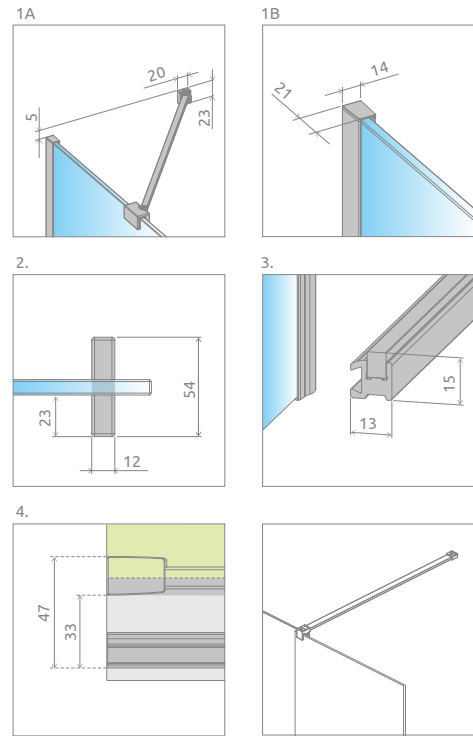
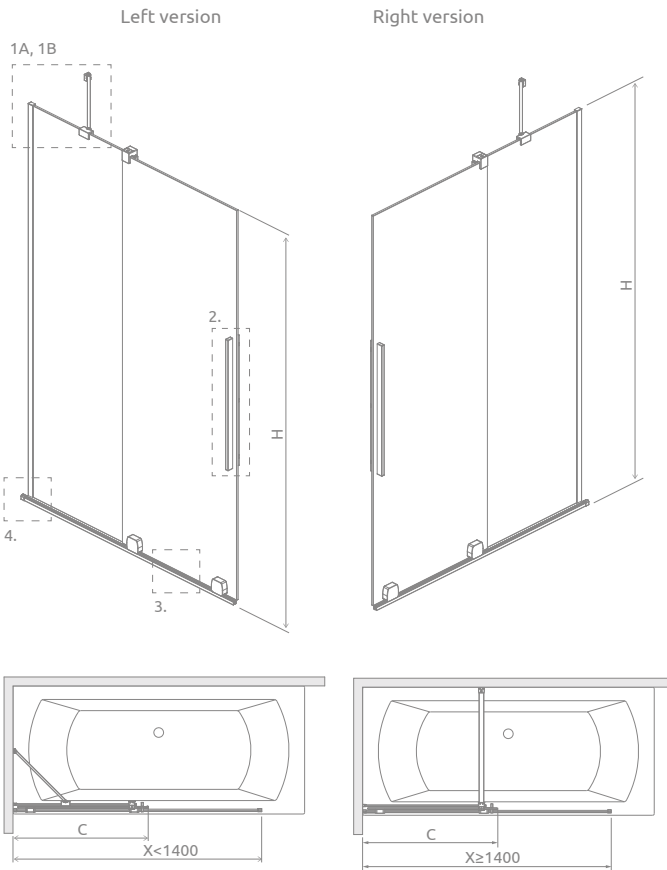

▲ For dimensions ≥ 1400 mm, the bathtub screen has a perpendicular support bar.

◀ It is possible to make the product with a railing handle ¹⁾ which also functions as a towel hanger.

◀ There is a possibility of a paid replacement of transparent gaskets (vertical and horizontal) for black gaskets. This option should be clearly stated in the order.

◀ Possibility of replacing the standard handle with a 35×120 mm hole cut in the glass pane.

Min. width of flat side of bathtub is 43 mm, and its slope max 1 mm.

Model	X	C	H
PND II 100	990-1000	553-563	1500
PND II 110	1090-1100	603-613	1500
PND II 120	1190-1200	653-663	1500
PND II 130	1290-1300	703-713	1500
PND II 140	1390-1400	753-763	1500
PND II 150	1490-1500	803-813	1500
PND II 160	1590-1600	853-863	1500
PND II 170	1690-1700	903-913	1500
PND II 180	1790-1800	953-963	1500

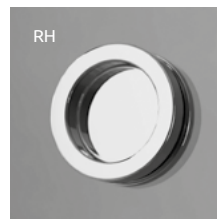

▲ It is possible to extend the entrance by 43 mm by replacing the vertical handle with a round one ¹⁾. Please contact the Customer Service Department.

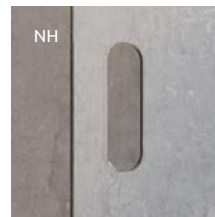
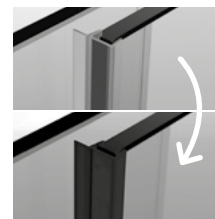

ADDITIONAL OPTIONS

MADE TO MEASURE p. 5	GLASS VARIANTS p. 9	PRINT/ENGRAVING ON GLASS p. 22/26	GASKETS COLOUR EXCHANGE p. 15	WIDER ENTRANCE p. 13	EXCHANGE OF HANDLE FOR A HOLE CUT IN GLASS p. 13	REPLACING THE HANDLE FOR A RAILING HANDLE p. 14

¹⁾ only chrome and black colour
Dimensions are given in mm.