

Nes 8 DWJ I

Nes DWJ I

Other colour versions of products from the series can be found on p. 258

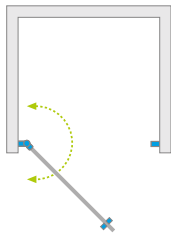

Nes 8



Nes

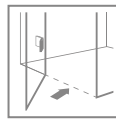

Profile finish:

Glossy:

Matte:

Brushed:



New *

01 Chrome

54 Black

99 Gold



Nes DWJ + Giaros C



Model	Nes 8 DWJ I transparent glass – 8 mm		Nes DWJ I transparent glass – 6 mm		
	profile finish: CHROME Art. No.	profile finish: BLACK Art. No.	profile finish: CHROME Art. No.	profile finish: BLACK Art. No.	profile finish: BRUSHED GOLD Art. No.
DWJ I 70 L	10076070-01-01L	10076070-54-01L	10026070-01-01L	10026070-54-01L	10026070-99-01L
DWJ I 70 R	10076070-01-01R	10076070-54-01R	10026070-01-01R	10026070-54-01R	10026070-99-01R
DWJ I 80 L	10076080-01-01L	10076080-54-01L	10026080-01-01L	10026080-54-01L	10026080-99-01L
DWJ I 80 R	10076080-01-01R	10076080-54-01R	10026080-01-01R	10026080-54-01R	10026080-99-01R
DWJ I 90 L	10076090-01-01L	10076090-54-01L	10026090-01-01L	10026090-54-01L	10026090-99-01L
DWJ I 90 R	10076090-01-01R	10076090-54-01R	10026090-01-01R	10026090-54-01R	10026090-99-01R
DWJ I 100 L	10076100-01-01L	10076100-54-01L	10026100-01-01L	10026100-54-01L	10026100-99-01L
DWJ I 100 R	10076100-01-01R	10076100-54-01R	10026100-01-01R	10026100-54-01R	10026100-99-01R

TECHNICAL DRAWINGS

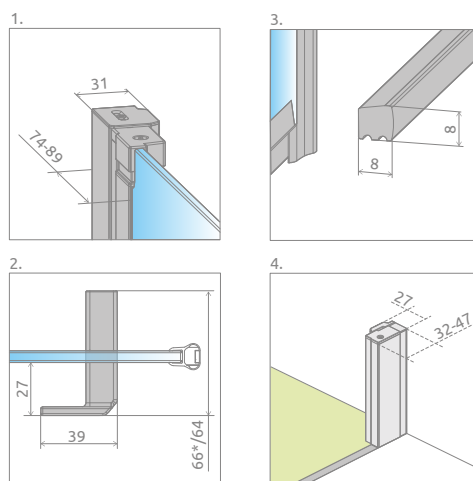
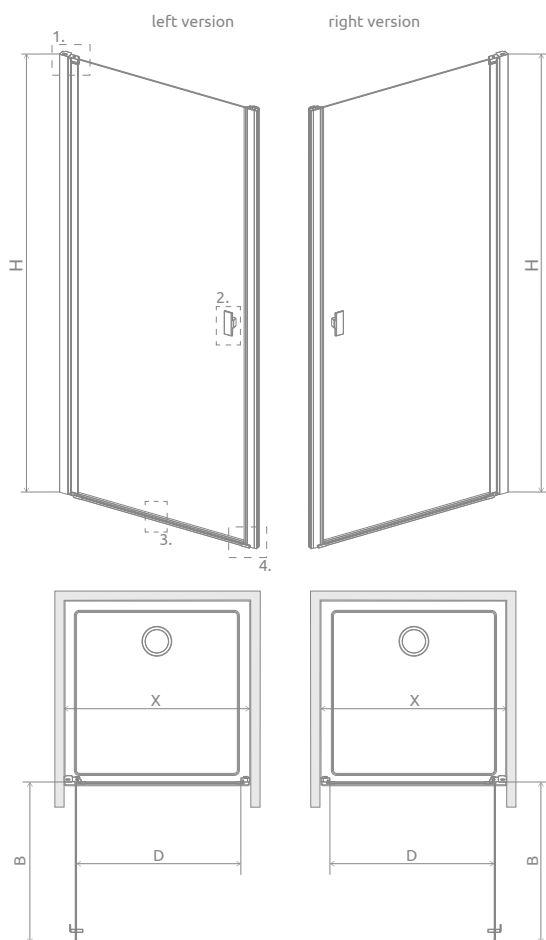

*Nes 8





There is a possibility of a paid replacement of transparent gaskets for black gaskets:
 - option no.1 – only magnetic gaskets,
 - option no. 2 – all gaskets (magnetic, vertical and horizontal).
 The selected option must be clearly stated in the order.

Model	X	B	D	H
DWJ I 70	680-710	580	580	2000
DWJ I 80	780-810	680	680	2000
DWJ I 90	880-910	780	780	2000
DWJ I 100	980-1010	880	880	2000

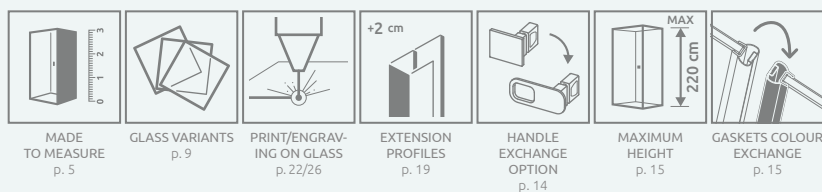
ADDITIONAL OPTIONS



Extension profiles	profile finish: CHROME Art. No.	profile finish: BLACK Art. No.	profile finish: BRUSHED GOLD Art. No.
 Profile + 2 cm* – it can be mounted only on the side of a profile hinge	P01-276200001	P01-276200054	P01-276200099
 Profile + 2 cm* – it can be mounted only on the side of the magnet-catch profile	P01-277200001	P01-277200054	–

* possibility of connecting extension profiles

RECOMMENDED SHOWER TRAYS

