

Wariant LEWY
Variant L

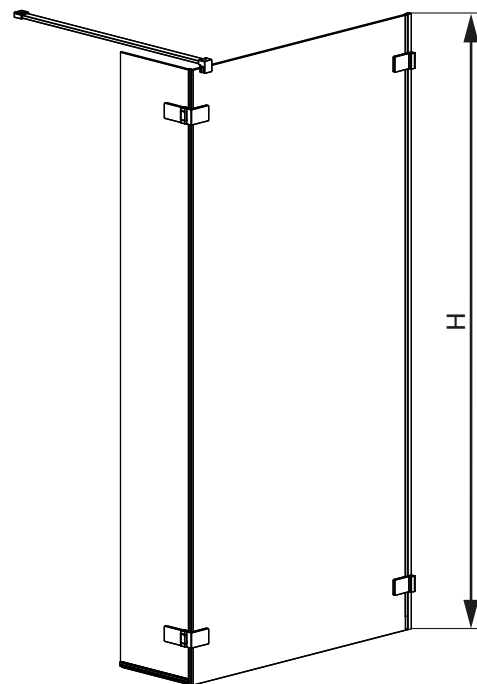

Wariant PRAWY
Variant R

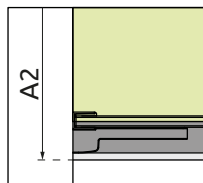
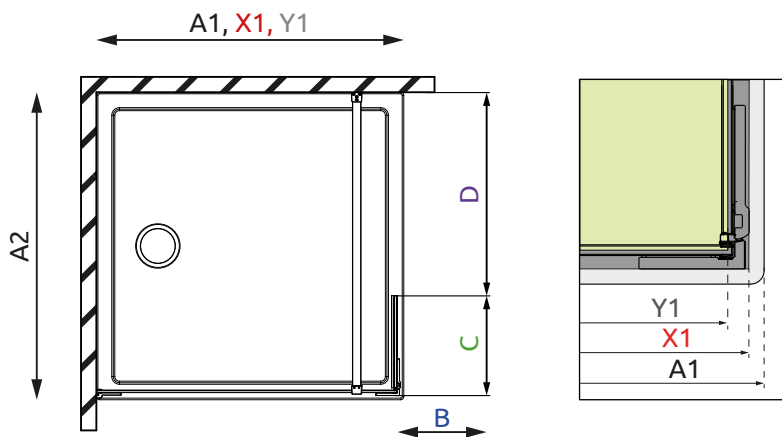

DRZWI WALK-IN

Model	B	C	D
Walk-In	358	400	maks. 810

FRONT W3 / FRONTWALL W3

Model	A1	A2	X1	Y1	H
W3 80	800	maks. 1200	786-796	773-783	2000
W3 90	900	maks. 1200	886-896	873-883	2000
W3 100	1000	maks. 1200	986-996	973-983	2000
W3 110	1100	maks. 1200	1086-1096	1073-1083	2000
W3 120	1200	maks. 1200	1186-1196	1173-1183	2000
W3 130	1300	maks. 1200	1286-1296	1273-1283	2000
W3 140	1400	maks. 1200	1386-1396	1373-1383	2000

