

Wariant LEWY  
Variant L

Wariant PRAWY  
Variant R

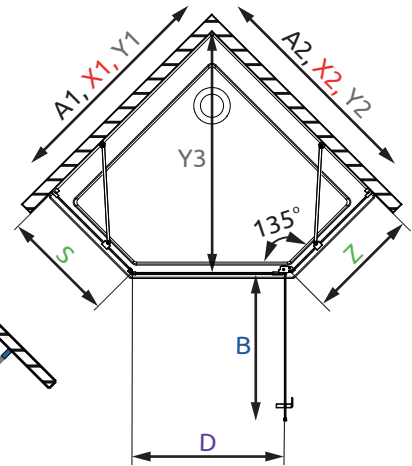
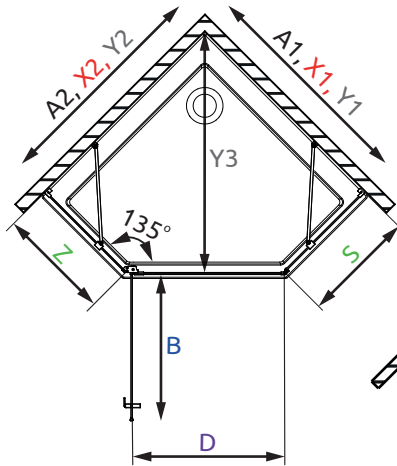
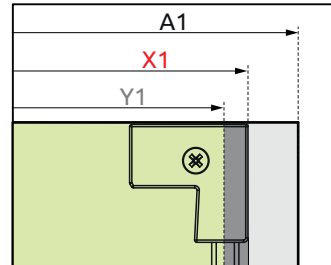
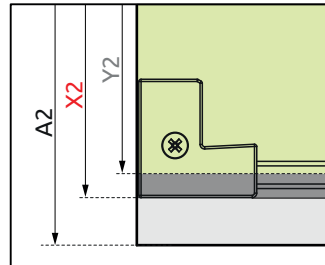

Wariant LEWY / Variant L

Wariant PRAWY / Variant R

Model	A1	A2	X1	X2	Y1	Y2	Y3	B	Z	S	D	H
PTJ 80Zx80S	800	800	775-790	775-790	770-785	770-785	778-799	577	332-347	334-349	570	2000
PTJ 90Zx90S	900	900	875-890	875-890	870-885	870-885	920-941	577	432-447	434-449	570	2000
PTJ 100Zx100S	1000	1000	975-990	975-990	970-985	970-985	1061-1082	577	532-547	534-549	570	2000
PTJ 80Zx90S	800	900	775-790	875-890	770-785	870-885	849-870	577	332-347	434-449	570	2000
PTJ 80Zx100S	800	1000	775-790	975-990	770-785	970-985	920-941	577	332-347	534-549	570	2000
PTJ 90Zx80S	900	800	875-890	775-790	870-885	770-785	849-870	577	432-447	334-349	570	2000
PTJ 90Zx100S	900	1000	875-890	975-990	870-885	970-985	990-1011	577	432-447	534-549	570	2000
PTJ 100Zx80S	1000	800	975-990	775-790	970-985	770-785	920-941	577	532-547	334-349	570	2000
PTJ 100Zx90S	1000	900	975-990	875-890	970-985	870-885	990-1011	577	532-547	434-449	570	2000

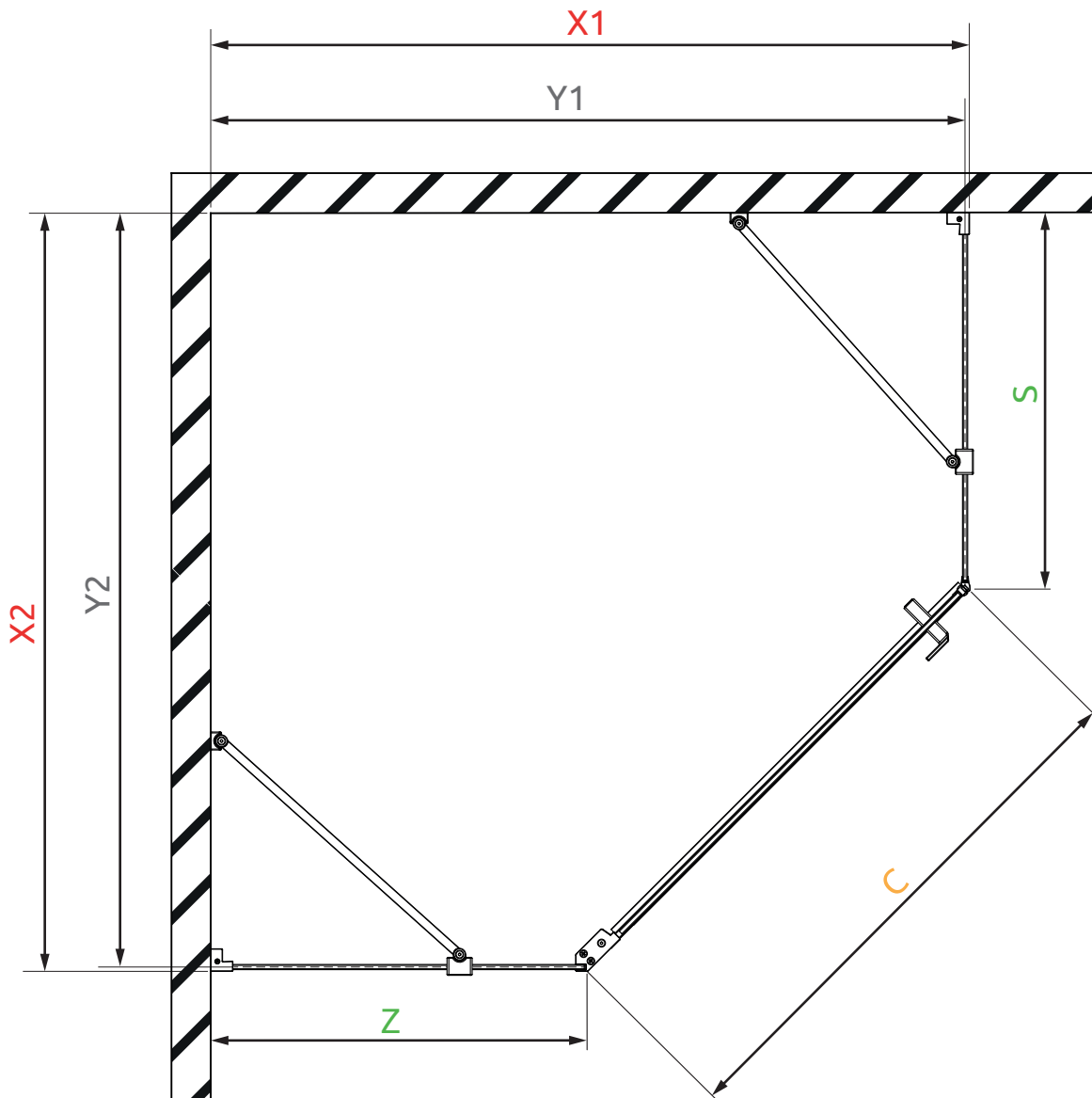

Model	X1*	X2*	Y1*	Y2*	Z*	S*	C*
<i>PTJ 80Zx80S</i>	780	780	775	775	337	339	624
<i>PTJ 90Zx90S</i>	880	880	875	875	437	439	624
<i>PTJ 100Zx100S</i>	980	980	975	975	537	539	624
<i>PTJ 80Zx90S</i>	780	880	775	875	337	439	624
<i>PTJ 80Zx100S</i>	780	980	775	975	337	539	624
<i>PTJ 90Zx80S</i>	880	780	875	775	437	339	624
<i>PTJ 90Zx100S</i>	880	980	875	975	437	539	624
<i>PTJ 100Zx80S</i>	980	780	975	775	537	339	624
<i>PTJ 100Zx90S</i>	980	880	975	875	537	439	624

\*Wymiary dotyczą montażu typowej kabiny montowanej zgodnie z instrukcją montażu  
 \*All dimensions refer to standard shower installation in accordance with the assembly instruction

